

MOREPORK FIREPLACES
FIREPLACE ONLY

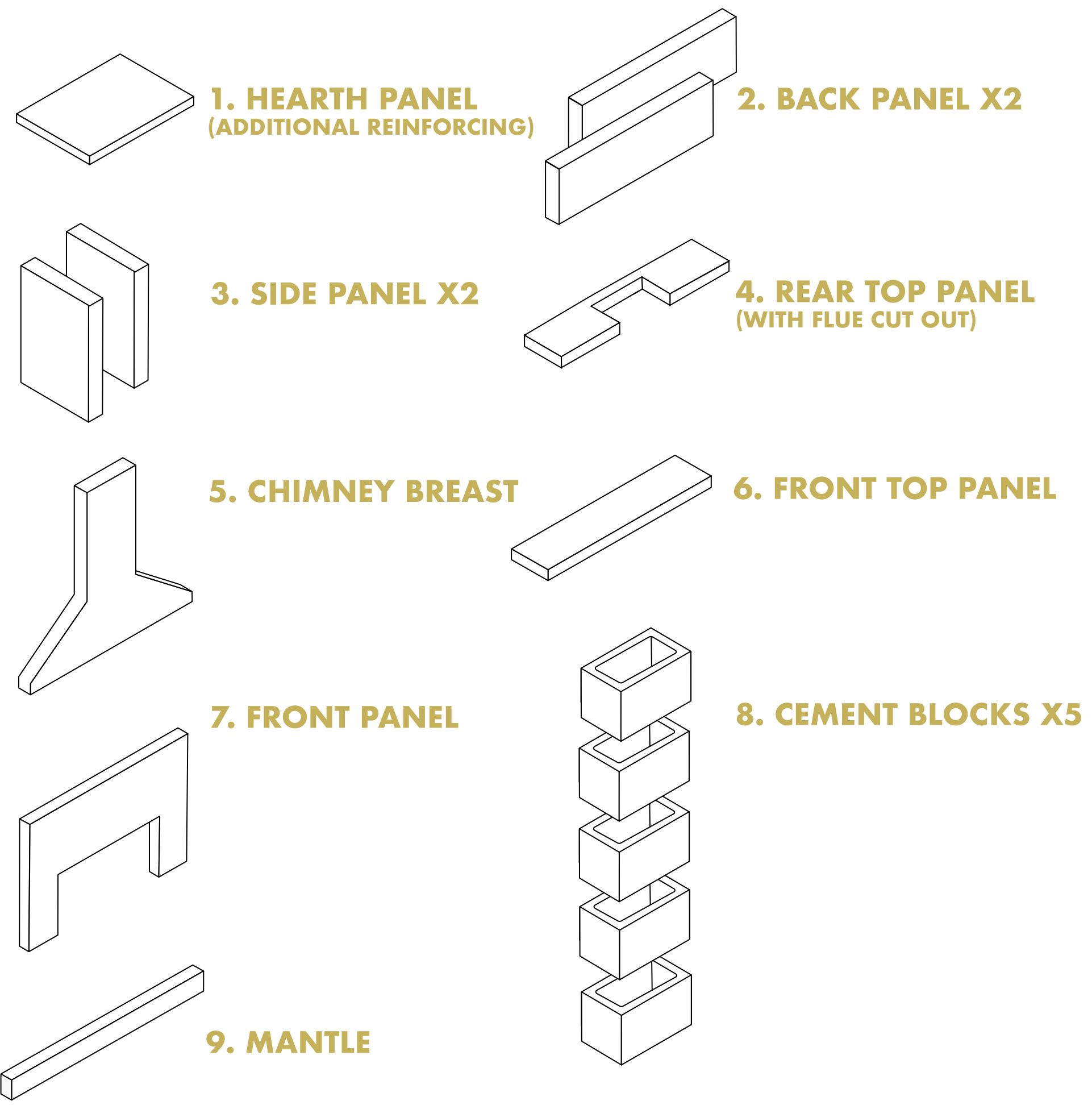

MOREPORK FIREPLACES
SINGLE BASE

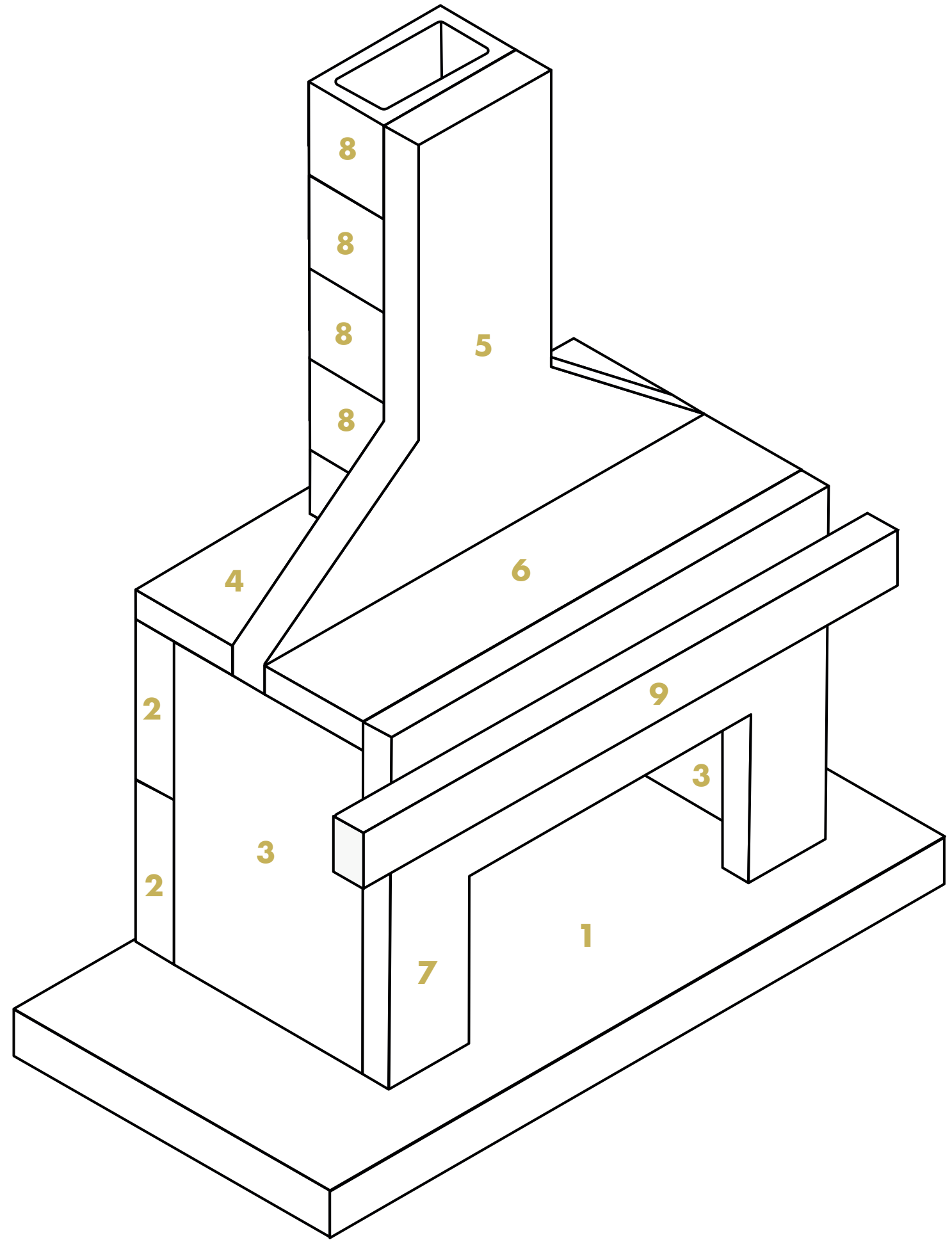
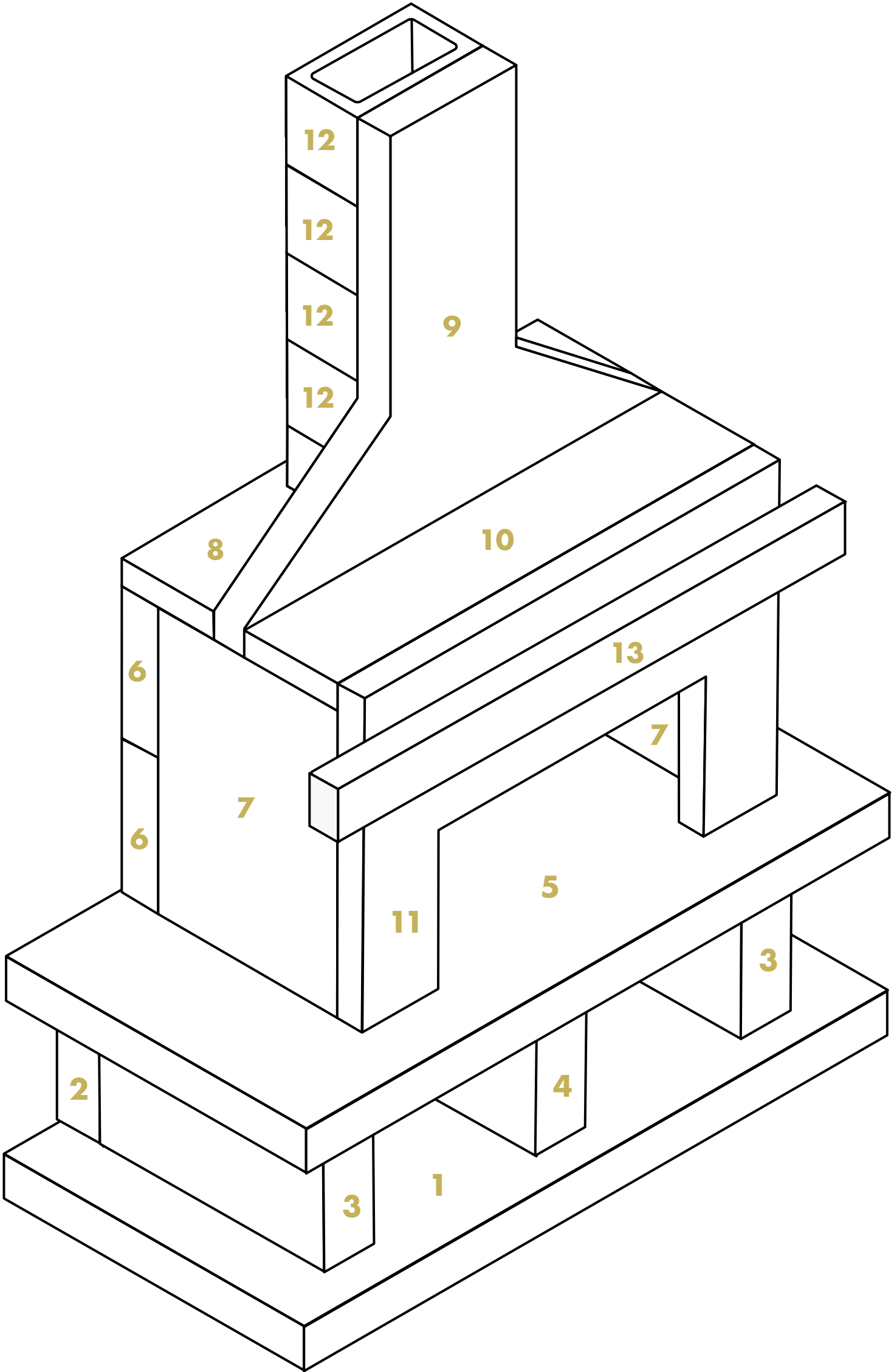
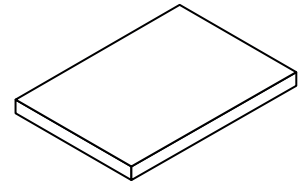

- 

1. GROUND PANEL
(OPTIONAL EXTRA)

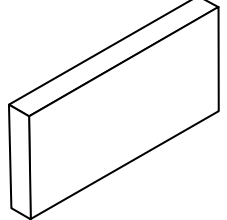

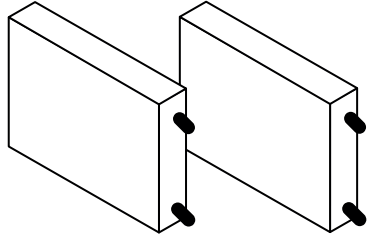
2. REAR BASE PANEL
(WITH CENTRE REBATE)
- 

3. END SUPPORT PANELS X2

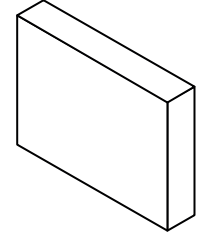

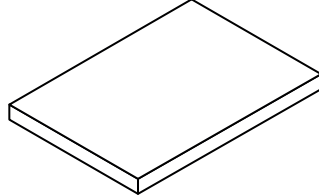
4. CENTRE SUPPORT PANEL
- 

5. HEARTH PANEL
(ADDITIONAL REINFORCING)

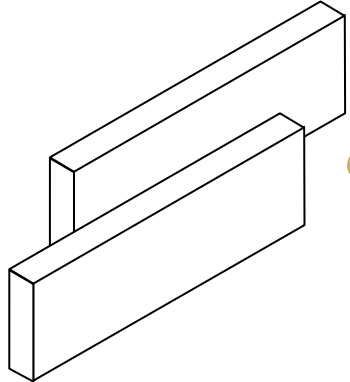

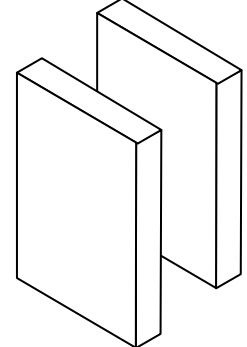
6. BACK PANEL X2
- 

7. SIDE PANEL X2

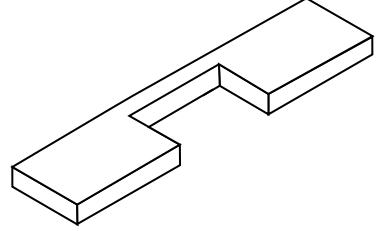

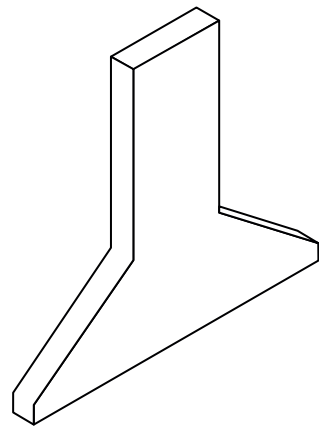
8. REAR TOP PANEL
(WITH FLUE CUT OUT)
- 

9. CHIMNEY BREAST

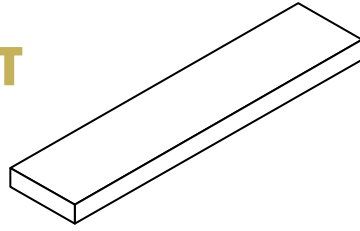

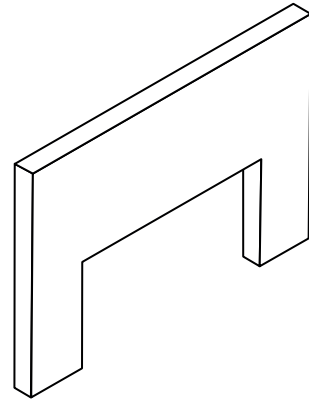
10. FRONT TOP PANEL
- 

11. FRONT PANEL

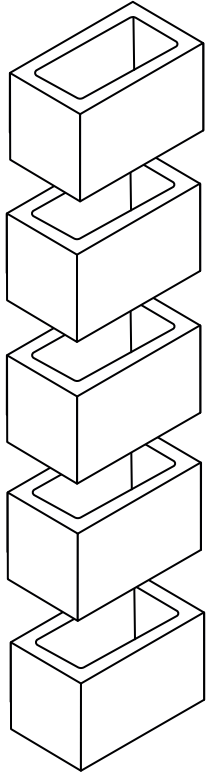

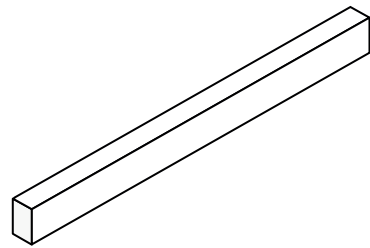
12. CEMENT BLOCKS X5
- 

13. MANTLE

FIREPLACE CONTENTS LIST

MOREPORK FIREPLACES
DOUBLE BASE

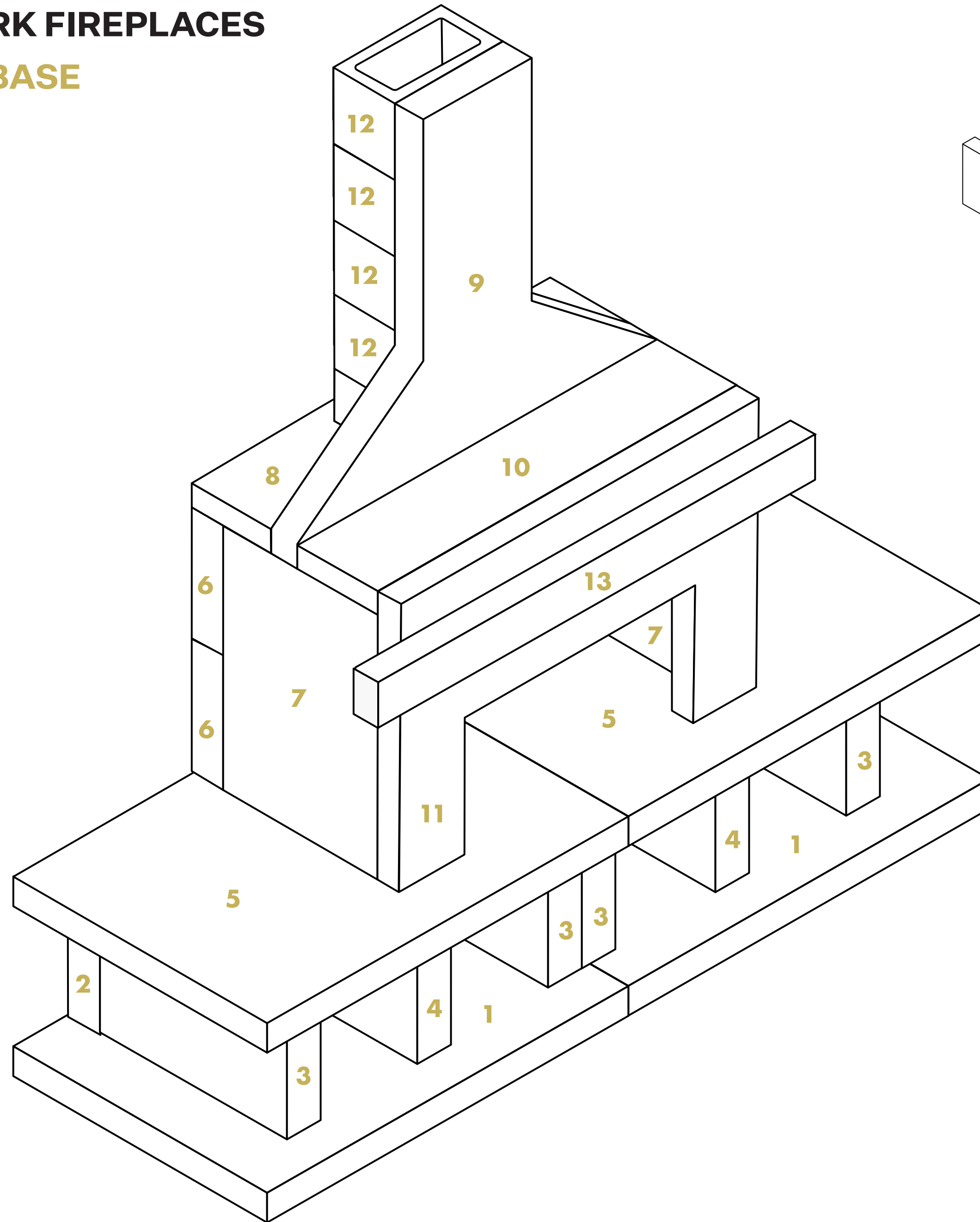

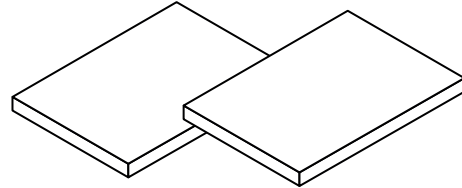
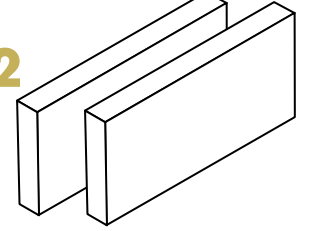
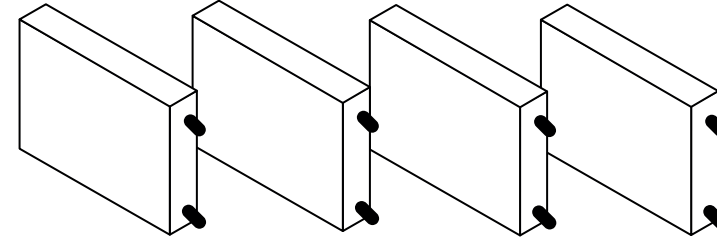
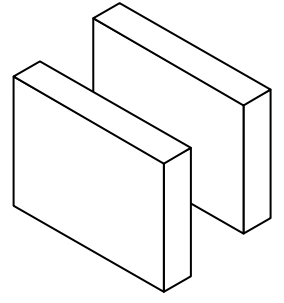
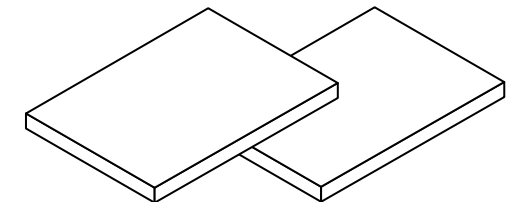
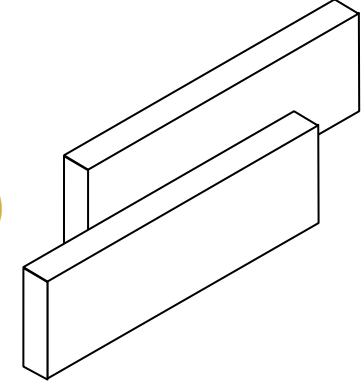
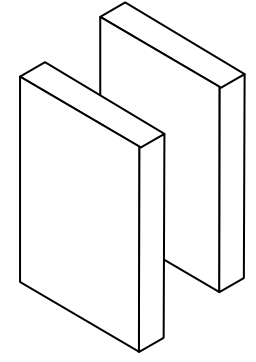
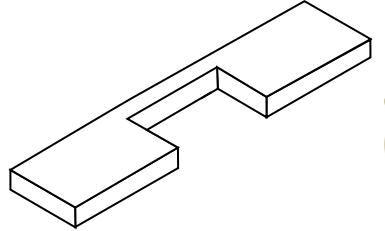
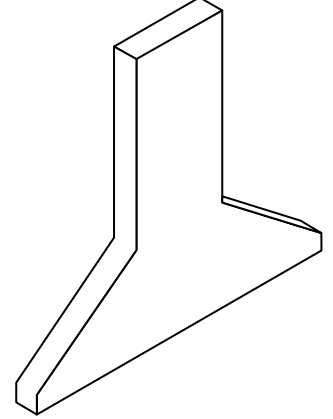
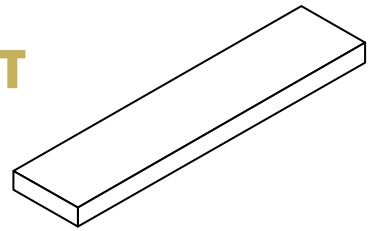
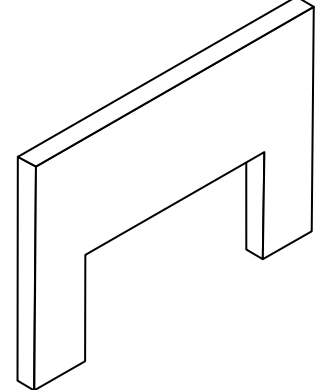
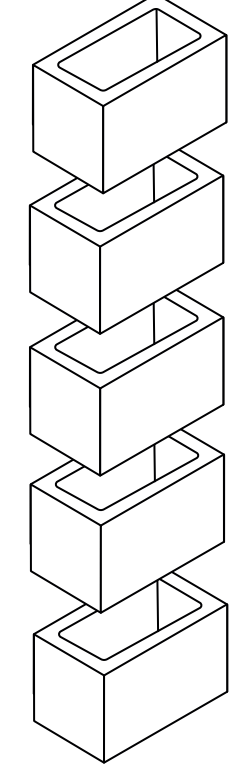
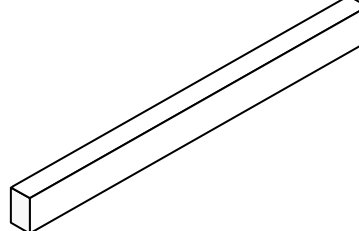
- 
1. GROUND PANEL X2

**2. REAR BASE PANEL X2
(WITH CENTRE REBATE)**
- 
**3. END SUPPORT
PANELS X4**

**4. CENTRE SUPPORT
PANEL X2**
- 
**5. HEARTH PANEL X2
(ADDITIONAL REINFORCING)**

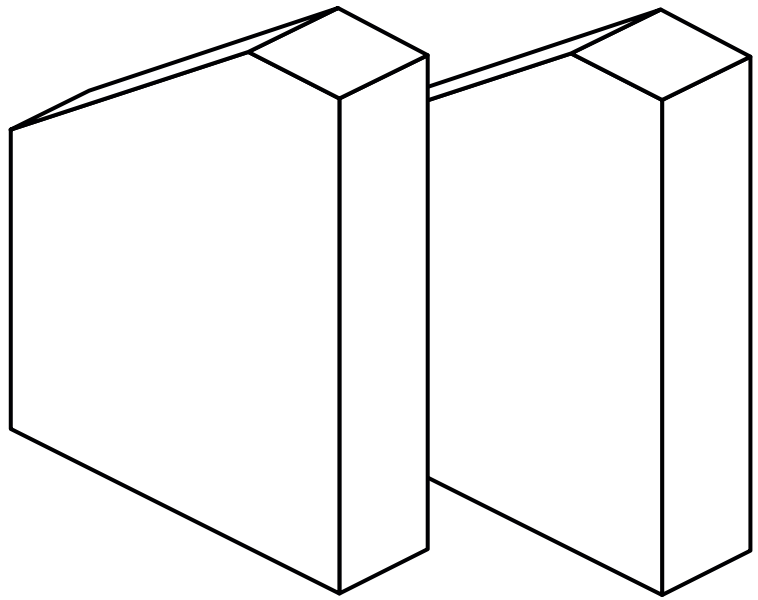
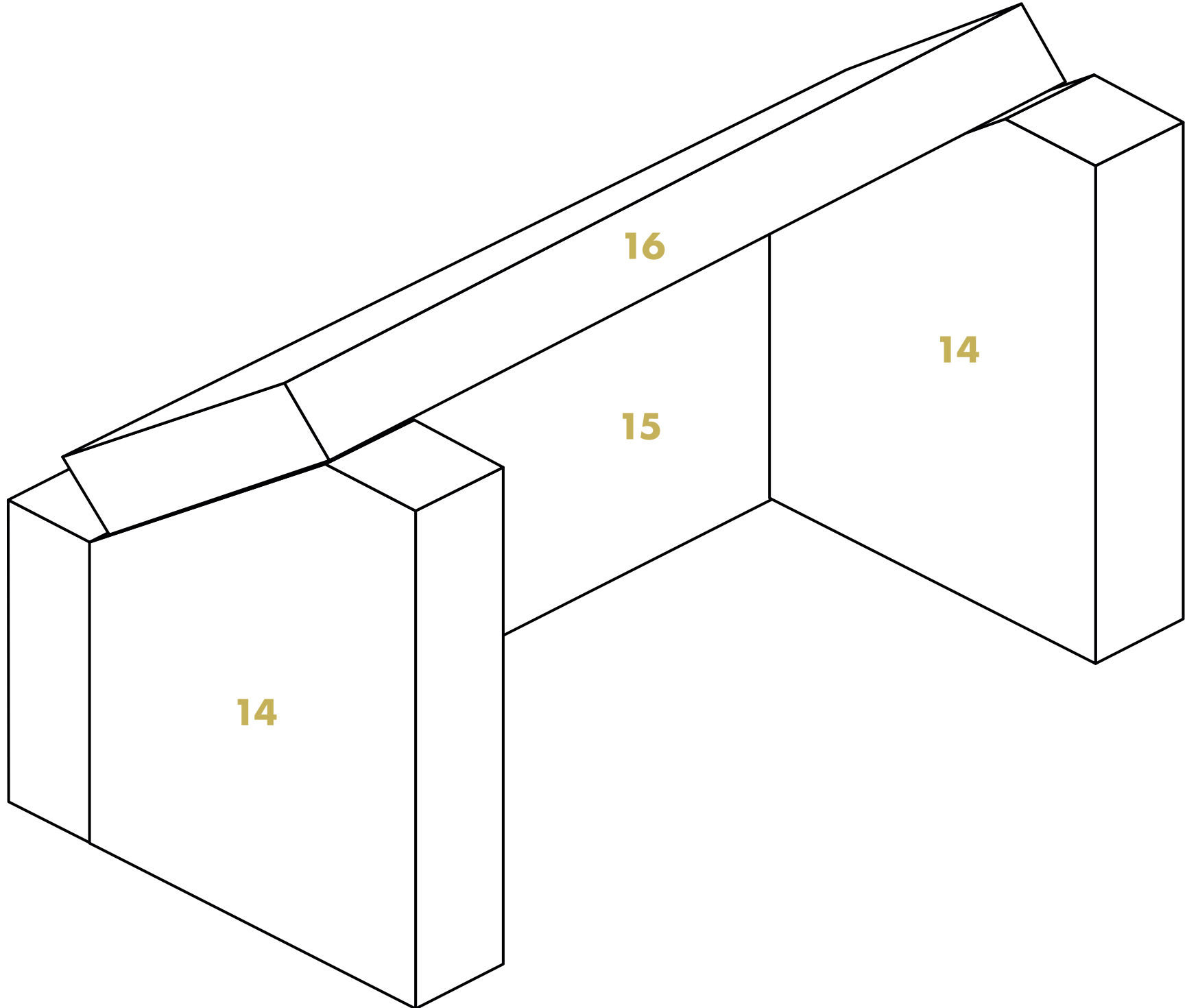
6. BACK PANEL X2
- 
7. SIDE PANEL X2

**8. REAR TOP PANEL
(WITH FLUE CUT OUT)**
- 
9. CHIMNEY BREAST

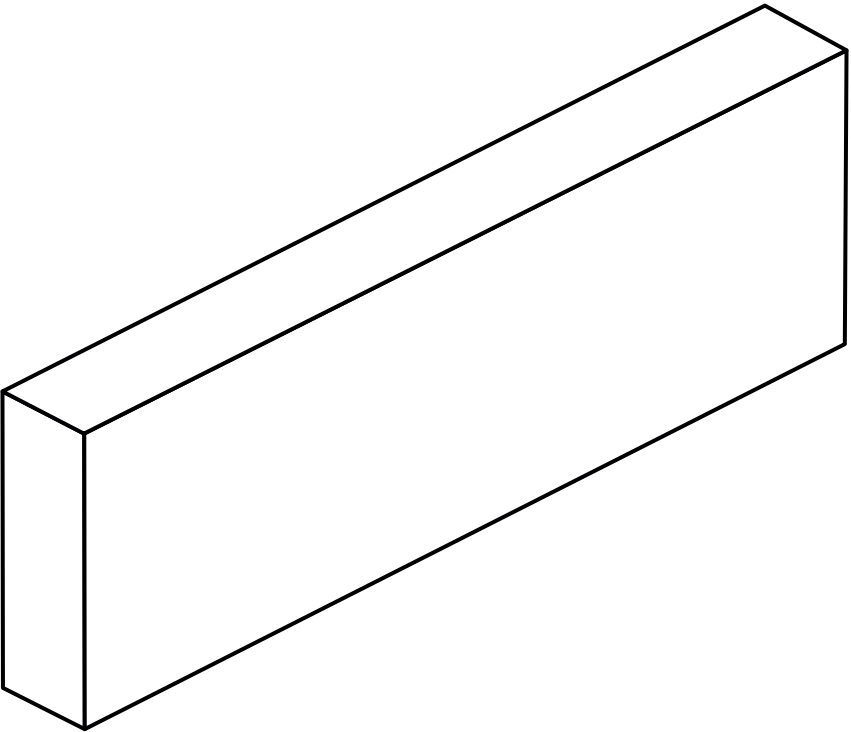
10. FRONT TOP PANEL
- 
11. FRONT PANEL

12. CEMENT BLOCKS X5
- 
13. MANTLE

FIREPLACE CONTENTS LIST

MOREPORK FIREPLACES
INSIDE PUMICE PANELS



14. SIDE PANEL X2



15. BACK PANEL

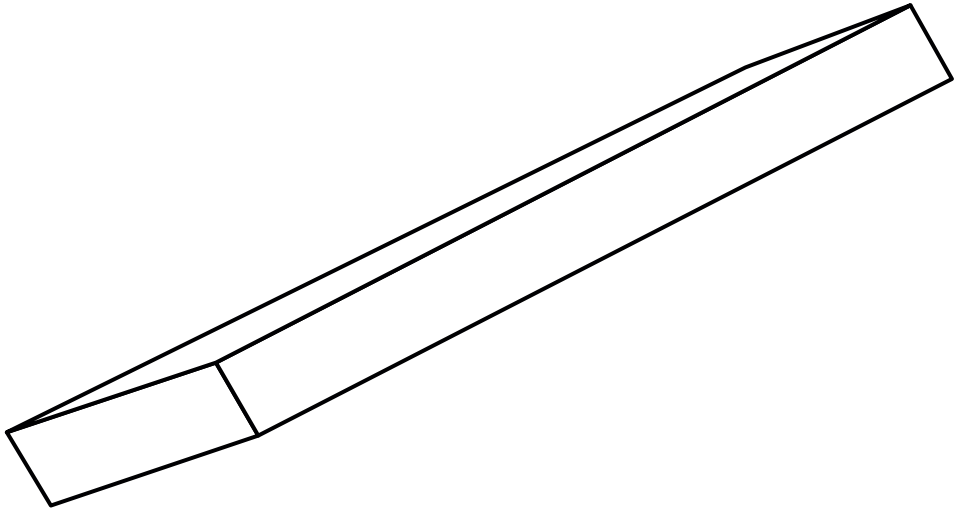

16. TOP PANEL